

ASHWORTH™
by Woodgrain Millwork

Installation Guidelines

Patio Doors

900 South 19th Street
West Des Moines, IA 50265
800.935.2000

www.ashworthdoors.com



ASHWORTH™

by Woodgrain Millwork

Installation Guidelines for Ashworth Patio Doors

Installer

- Read instructions completely before attempting installation. Failure to follow these guidelines will forfeit the Ashworth warranty coverage, written or implied.
- Always provide a copy of these instructions to the homeowner.
- These instructions are consistent with ASTM 2112 "Standard Practice for Installation of Exterior Windows, Doors and Skylights" into common wall constructions. Contact your architect or construction professional for installation into other building designs or construction methods.
- Regional codes and environmental conditions may require installation that is different from these guidelines. It is your responsibility to ensure that local codes and ordinances are followed.

Warning!

- ⚠ **Work Safe!** Always wear proper eye and hearing protection when installing or adjusting Ashworth products.
- ⚠ **Use Power Tools Properly!** To avoid personal injury, always follow manufacturers' instructions for safe operation of power tools.
- ⚠ **Ladder Safety!** Working at elevated levels can be hazardous. Always use ladders and scaffolding properly. Consult manufacturers' guidelines for safe use of these types of equipment.
- ⚠ **Safety Glazing!** Some Ashworth products may not contain safety glazing unless specifically ordered that way. Use caution – injury could result if glass is broken and fragmented. Building codes require safety glazing for windows installed in certain areas. Consult your local building code official for guidelines.

Important

- Ashworth reserves the right to change the information contained in these guidelines without notice.
- Maintain a minimum of 1/4" between the door frame and any trim, siding or masonry.
- Use of Ashworth products in barrier EIFS systems (synthetic stucco) is not recommended. To do so will forfeit all warranties (written or implied), and Ashworth will not be held responsible for any claims or damages resulting from water infiltration.
- Steel fasteners will corrode when used with ACQ Pressure Treated Lumber. Use corrosion resistant fasteners (such as stainless steel) when installing windows in or around these types of materials.
- Door nailing flanges and drip caps (integral or applied) do not take the place of window flashing. All windows and doors must be properly flashed and sealed around the perimeter.

Handling and Storage

- Always carry door units upright. Do not carry flat! Doing so could result in damage to the unit.
- Do not store units outside.

Note: These installation instructions contain two methods of installation – nail fin and no nail fin installation.

Tools Needed

- Safety Glasses
- Utility Knife
- Hammer (or nail gun)
- Caulk Gun
- Level
- Ladder / Scaffolding
- Square
- Tape Measure
- Stapler
- Screwdriver



Materials Needed

- Backer Rod
 - 1/4"-1/2" diameter closed cell foam
- Insulation
 - Minimally expanding low pressure polyurethane window and door foam
- Shims
 - Made of cedar or synthetic material
- 2-1/2" Drywall Screws
 - (No Nail Fin Installation)
- Roofing Nails (Nail Fin Installation)
 - 2" Galvanized (16D)
- Silicone Sealant
 - 100% Silicone
- Flashing (Nail Fin Installation)
 - Self-adhesive flexible flashing that complies with ASTM-D779

Step 1: Inspect Unit

Before Installation:

- Remove all shipping packaging material (blocks, pads, protectors, stretch wrap).
- Inspect unit for any damage or defects.
- Verify the door unit is the correct size and configuration.
- Contact the nearest Ashworth distributor if there is a problem.

Step 2: Prepare Rough Opening

Note: Disregard steps B, F, G, H and I if No Nail Fin Installation is utilized.

- Measure and verify the size of the rough opening. The rough opening should be 3/4" larger in width and 1/2" larger in height than the frame size.
- For doors with clad exterior casings, additional nailer studs may be required around the perimeter of the rough opening.
- Verify the rough opening is flat, plumb, level and square. (Fig. 1)
- Take diagonal measurements to check for square. (Fig. 1)
- Make sure the bottom sill area of the rough opening is flat and level. Correct rough opening if sloped toward the interior; out of level or humped. (Fig. 1)
- Cut the weather-resistant barrier (WRB) in a "Modified I" pattern. (Fig. 2)
- Fold back the WRB on the sides toward the interior and staple into place. (Fig. 3)
- From the exterior; cut the top of the WRB as shown to form a flap. (Fig. 4)
- Temporarily tape this top flap up. (Fig. 4)

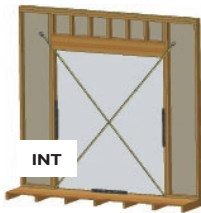

FIG. 1

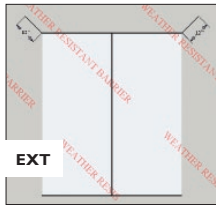

FIG. 2

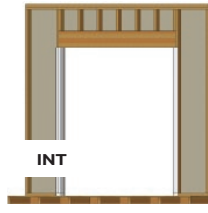

FIG. 3

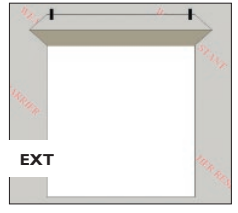

FIG. 4

Step 3: Flashing the Sill

A) **IMPORTANT!**

- a. Use flashing that is 6" minimum in width.
 - b. Flashing must meet ASTM-D779 performance requirements.
- B) Measure the width of the rough opening. Cut a length of flashing that is 12" wider than the rough opening. This will allow you to run the flashing 6" up each side.
- C) Cut 1-1/2" slits at each end of the flashing as shown below. (Fig. 5)



- D) Apply sill flashing to the rough opening as shown below. (Fig. 6)
- E) Flashing tape must cover the entire sill. If needed, apply an additional flashing piece over the first one (start from the exterior and work toward the interior). Maintain a minimum 1" overlap. (Fig. 7)

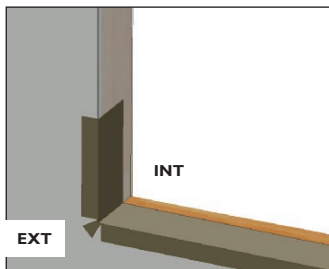

FIG. 6

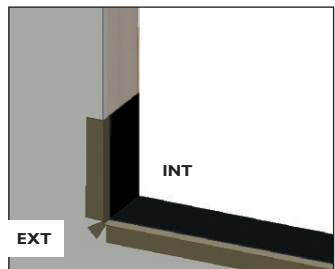

FIG. 7

Step 4a: Nail Fin Door Installation (Go to Step 4b for No Nail Fin Installation)

- A) Remove all packaging material (blocks, pads, protectors, stretch wrap, nail fin).
- B) Inspect and verify the following:
 - a. The door unit is the correct size and configuration.
 - b. The unit is free from any damage or defects.
- C) Contact your nearest Ashworth distributor if there are any problems with step B above.
- D) Install the supplied nail fin to both sides and top of the door as shown below. The location of the nail fin depends on the jamb depth of the rough opening. Ensure the correct location is chosen prior to applying the nail fin. (Fig. 8)
- E) Apply the supplied nail fin corner gaskets.
- F) Apply sealant to the outside face of the nail fin. Tool in sealant to ensure no voids. (Fig. 9)

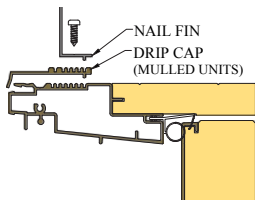

FIG. 8

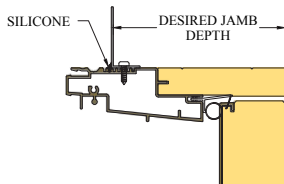

FIG. 9

- G) Install upper nail fin corner gaskets. (Fig. 10)
 - a. Remove protective paper from back of nail fin corner gasket.
 - b. Place foam nailing fin gasket over corner with inside corner of the gasket tight against outside frame corner.
 - c. Repeat application at all corners where the nail fins meet.
- H) Apply sealant to the interior side of the head and side nail fin. Apply a 1/4" continuous bead of silicone in line with and completely covering the nail fin holes. (Fig. 11)

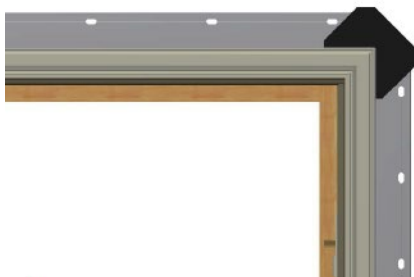

FIG. 10



FIG. 11

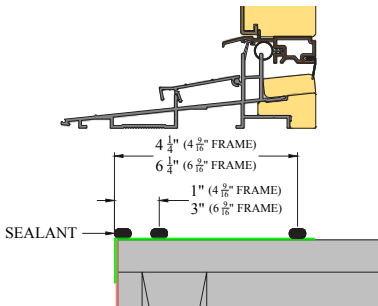

FIG. 12: 4-9/16" & 6-9/16" IN-SWING PATIO DOOR SILL

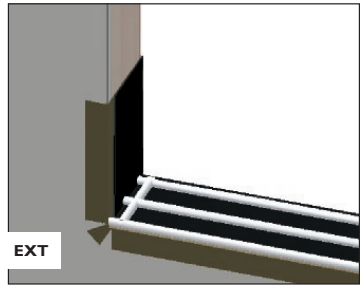

FIG. 13

- I) Apply sealant to sill rough opening:
 - a. Apply three 1/4" continuous beads of silicone across the entire width of the rough opening. Note the locations are different for each door type. Fig. 13 shows the silicone location for a 4-9/16" and 6-9/16" in-swing door. The bead location will be different for other jamb sizes. (Fig. 12)
 - b. Apply a 1/4" continuous bead of silicone 1/2" from each side of the rough opening. The bead will run the entire depth of the jamb starting at the face of the wall. (Fig. 13)
- J) Set the door into the rough opening. Center the unit in the opening, making sure there are equal gaps on both sides of the door.
- K) Temporarily tack the door in place using 2" galvanized roofing nails through the pre-punched holes at both top corners of the nailing flange. Do not drive the nails in fully.
- L) Start with a shim at each corner no more than 1" from the jamb corner. Add additional shims spaced evenly from the center of the unit make sure shims are spaced no more than 16" apart. Note to use flat shims or pairs of triangle shims to ensure the jamb does not twist. (Fig. 14)
- M) Additional shims are required at each lock point, head shootbolt and hinge location for all operating doors. (Fig. 14)
- N) Nail all four corners in place through the pre-punched holes in the nail flange.
- O) Finish nailing the door to the rough opening. Use a nail at each nail fin hole, 8"-10" apart.

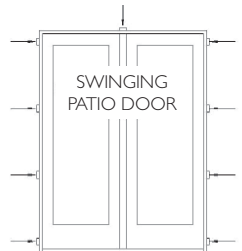

FIG. 14

Step 4b: No Nail Fin Door Installation

- A) Remove all packaging material (blocks, pads, protectors, stretch wrap).
- B) Inspect and verify the following:
 - a. The door unit is the correct size and configuration.
 - b. The unit is free from any damage or defects.
- C) Contact your nearest Ashworth distributor if there are any problems with step B above.
- D) Measure in from the exterior side of the unit 2-5/8" and mark this at four equally spaced points along each side jamb and three equally spaced points along the head jamb. Then drill a 1/8" pilot hole through the entire unit at each of the 11 marked places. (Fig. 15)

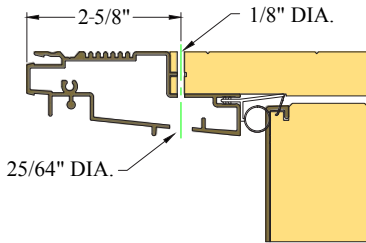

FIG. 15

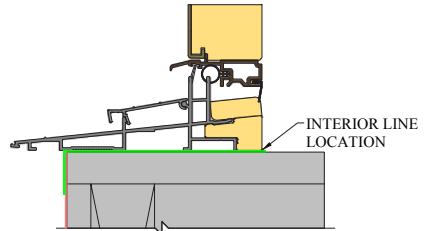

FIG. 16

- E) After the pilot hole has been created, drill a 25/64" hole through the aluminum cladding only. (Fig. 15)
- F) Test fit the unit in the rough opening and set the unit to the appropriate jamb depth. Once the correct jamb depth has been determined, draw a line along the inside of the sill on the subfloor. (Fig. 16)
- G) Remove the unit from the opening.
- H) Apply sealant to sill rough opening:
- Apply three 1/4" continuous beads of silicone across the entire width of the rough opening. (Fig. 17) shows the silicone location for a 4-9/16" and 6-9/16" in-swing door. The bead location will be different for other jamb sizes. (Fig. 17)
 - Apply a 1/4" continuous bead of silicone 1/2" from each side of the rough opening. The bead will run the entire depth of the jamb starting at the face of the wall. (Fig. 18)

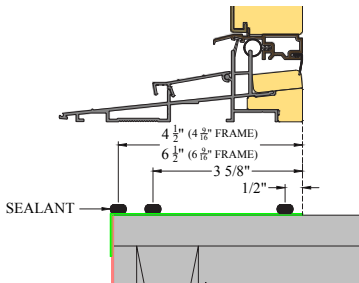

FIG. 17: 4-9/16" & 6-9/16" IN-SWING PATIO DOOR SILL

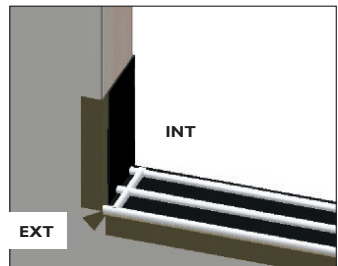

FIG. 18

- I) Set the door into the rough opening. Center the unit in the opening, making sure there are equal gaps on both sides of the door.
- J) Temporarily hold the door in place using 2-1/2" drywall screws through the pre-drilled holes at both top corners of the door frame. Do not drive the screws in fully.
- K) Start with a shim at each corner no more than 1" from the jamb corner. Add additional shims at each pre-drilled frame hole. Note to use flat shims or pairs of triangle shims to ensure the jamb does not twist. (Fig. 19)
- L) Additional shims are required at each lock point, head shootbolt and hinge location for all operating doors. (Fig. 19)



FIG. 19

- M) Screw all four corners in place through the pre-drilled holes in the frame.
- N) Finish screwing the door to the rough opening. Apply a screw through all 11 pre-drilled frame holes.

Step 5: Secure Hinge and Verify Operation

- A) Apply the supplied # 12 x 2-1/4" screws through each hinge securing the hinges and frame to the rough opening. Additional shims are required behind each hinge. (Fig. 20)
- B) Verify the operation of the door is correct. By doing so you will verify the door swings without binding on another member of the door and by remaining motionless throughout the operation when left in static position.
- C) If the operation of the door is not correct, first verify the rough opening is plumb, level and square. Second, verify the door is shimmed and fastened properly as stated in these instructions. Third, verify the hinges are adjusted to the optimal position.

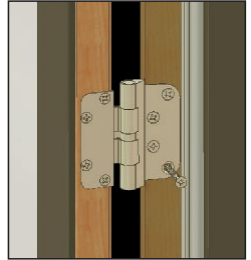

FIG. 20

Step 6: Completing the Sill

Note: Disregard Step A if No Nail Fin Installation is utilized.

- A) **IMPORTANT!** Below the nail fin at both bottom corners, apply a generous amount of silicone to seal the void between the rough opening and the sill. If the gap is too large, insert backer material in the void prior to sealing. (Fig. 21)
- B) Attach a sill support block beneath the sill. Apply a bead of sealant at the nose of the sill and support block. (Fig. 22)
- C) Apply silicone to seal each end of the sill cavity that protrudes from the rough opening. (Fig. 23)

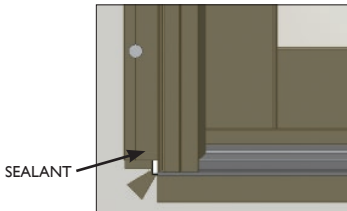

FIG. 21

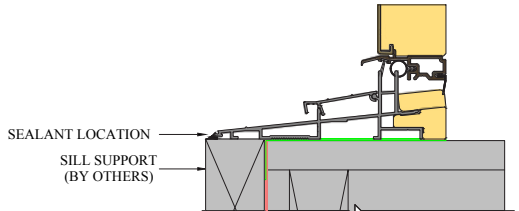

FIG. 22: STANDARD DOOR SILL

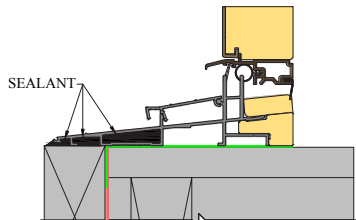

FIG. 23: IN-SWING SILL

Step 7: Complete Flashing (Nail Fin Installation Only)

- Cut and apply side flashing. Side flashing should run from the bottom of the sill flashing to 4" above the rough opening. (Fig. 24)
- If non-adhesive flashing is used, make sure all staple holes are sealed with silicone.
- Cut and apply head flashing. The head flashing should run slightly past the edge of the side flashing as shown. (Fig. 25)
- Flip down the top flap of the WRB. (Fig. 26)
- Tape the cut seams of the WRB. (Fig. 27)



FIG. 24



FIG. 25



FIG. 26



FIG. 27

Step 8: Seal the Exterior

- After siding or wall exterior is complete, apply backer rod and sealant between the door frame and siding material on both sides. See figures 28 and 29 for nail fin installation and figures 30 and 31 for no nail fin installation.
- WARNING:** Maintain a minimum of 1/4" between the door frame and any trim, siding or masonry. Failure to do so will forfeit all warranties (written or implied). Ashworth will not be held responsible for any claims or damages resulting in failure to follow these instructions.

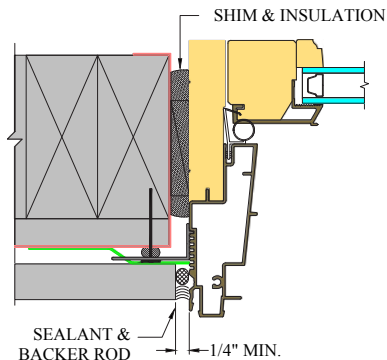

FIG. 28: SIDE JAMB –
NAIL FIN INSTALLATION

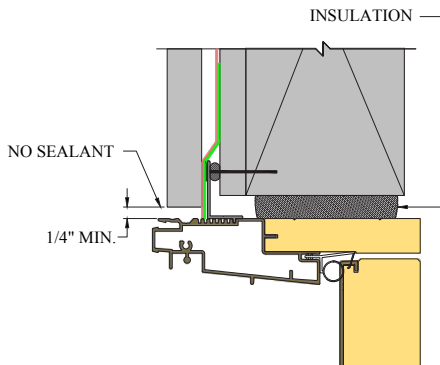

FIG. 29: HEAD JAMB –
NAIL FIN INSTALLATION

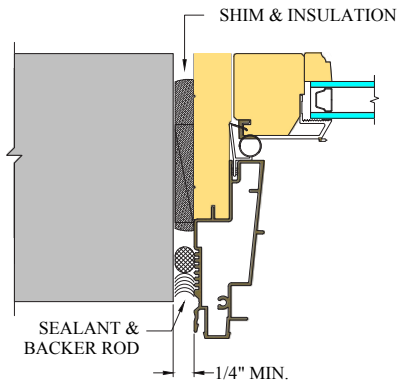

FIG. 30: SIDE JAMB – NO NAIL FIN INSTALLATION

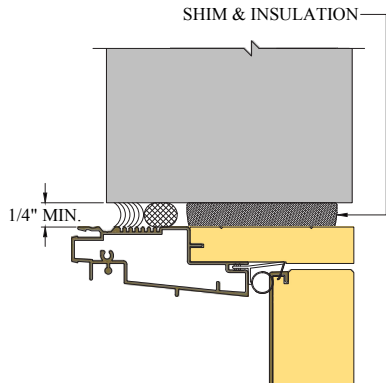

FIG. 31: HEAD JAMB – NO NAIL FIN INSTALLATION

Step 9: Completing the Installation

- A) Remove all labels or shipping materials.
- B) Hinge adjustment may be required to complete the installation. (Fig. 32)
 - a. When adjusting the hinge, use a hand screwdriver.
 - b. Use the top and bottom hinge to adjust the door panel horizontally.
 - c. Use the center hinge to adjust the door panel vertically.
- C) Insulate between the door frame and the rough opening using minimally expanding window and door spray foam insulation. Use caution to not overfill the gap causing the jambs to bow. It is not recommended to apply trim to the unit until the foam has cured to allow the excess to escape. (Fig. 28, 29, 30 & 31)
- D) Operate door unit to ensure proper operation. The panel will not operate correctly if the door is out of square, over-shimmed or over-insulated.
- E) Properly finish all Interior wood components within 30 days of installation.
- F) **IMPORTANT:** Do not stain or paint any hardware or vinyl components.
- G) Apply the handle set as appropriate per the manufacturer's recommendations. Complete final adjustments as necessary.
- H) Swinging doors are to remain closed and locked during construction to prevent site conditions from damaging and/or warping panels and frames. Allow 10-12 weeks from project completion for building temperature and humidity levels to stabilize and door panels to acclimate.

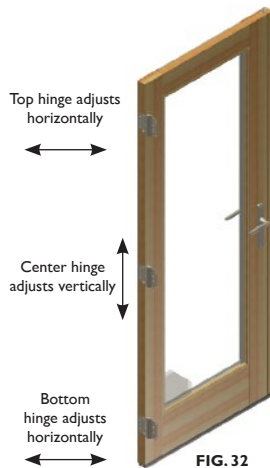

FIG. 32

If you should have any questions from installation to adjustments of the Ashworth by Woodgrain Millwork products, please contact Ashworth directly at 1.800.935.2000. Visit www.ashworthdoors.com to find additional information on your Ashworth Door including maintenance, finishing and warranty information to help assist you in preserving the integrity and reliability of your Ashworth products.